

SLID'UP
by MANTION

INSTRUCTION DE MONTAGE
MONTAGEANLEITUNG
INSTRUCTIONS FOR ASSEMBLY
INSTRUCCIONES DE MONTAJE
INSTRUKCJA MONTAŻU

SLID'UP 130

SU5114
SU5115
SU5116
SU5117
SU5118
SU5119

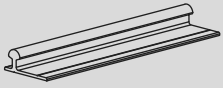

x4



x4/x6



x4/x6



x2/x3



x1

70
KG

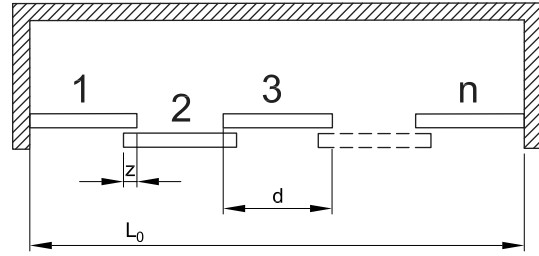
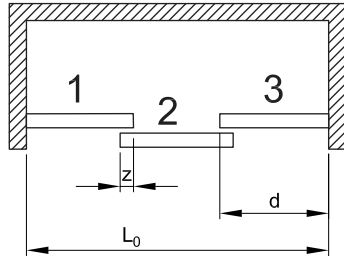
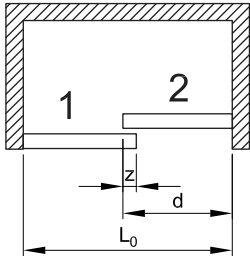

$$d = \frac{L_0 + (n-1) \cdot z}{n} \quad z=40$$

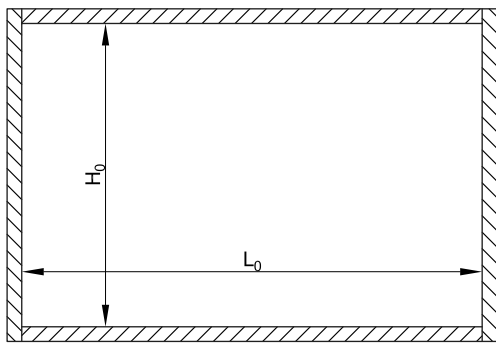

min H_0

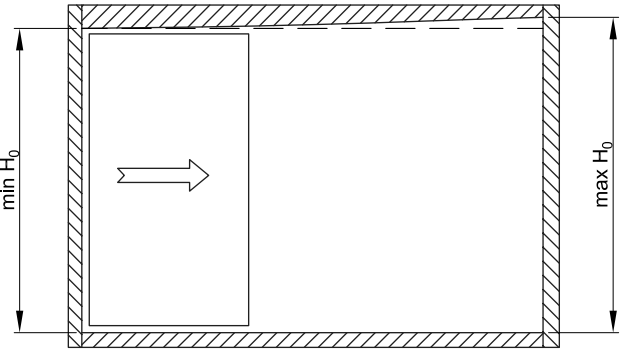

max H_0



$$\max H_0 - \min H_0 \leq 4\text{mm}$$

$t \leq 18$

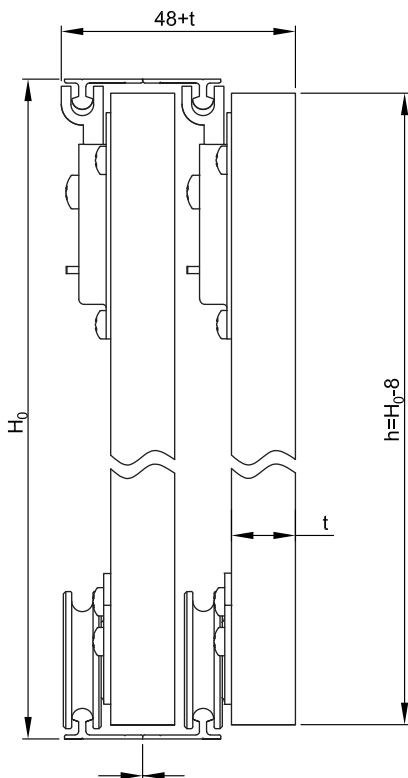

$t > 18$

