



x1



x1



x2

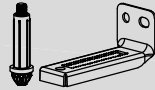

x2

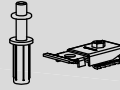

x2

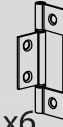

x6



14KG
30lb

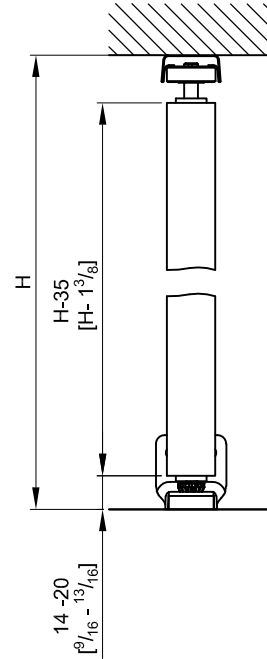
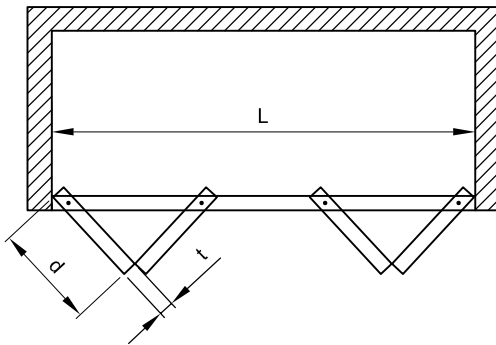

t [mm]	<28	28 ÷ 30	31 ÷ 38
x [mm]	0	2	4
t [in]	<1 ¹ / ₈	1 ¹ / ₈ ÷ 1 ¹ / ₄	
x [in]	1 ¹ / ₁₆	1 ¹ / ₈	

$$d = (L/4 - 3) - x$$

$$[d = (\frac{L}{4} - \frac{1}{8}) - x]$$

1

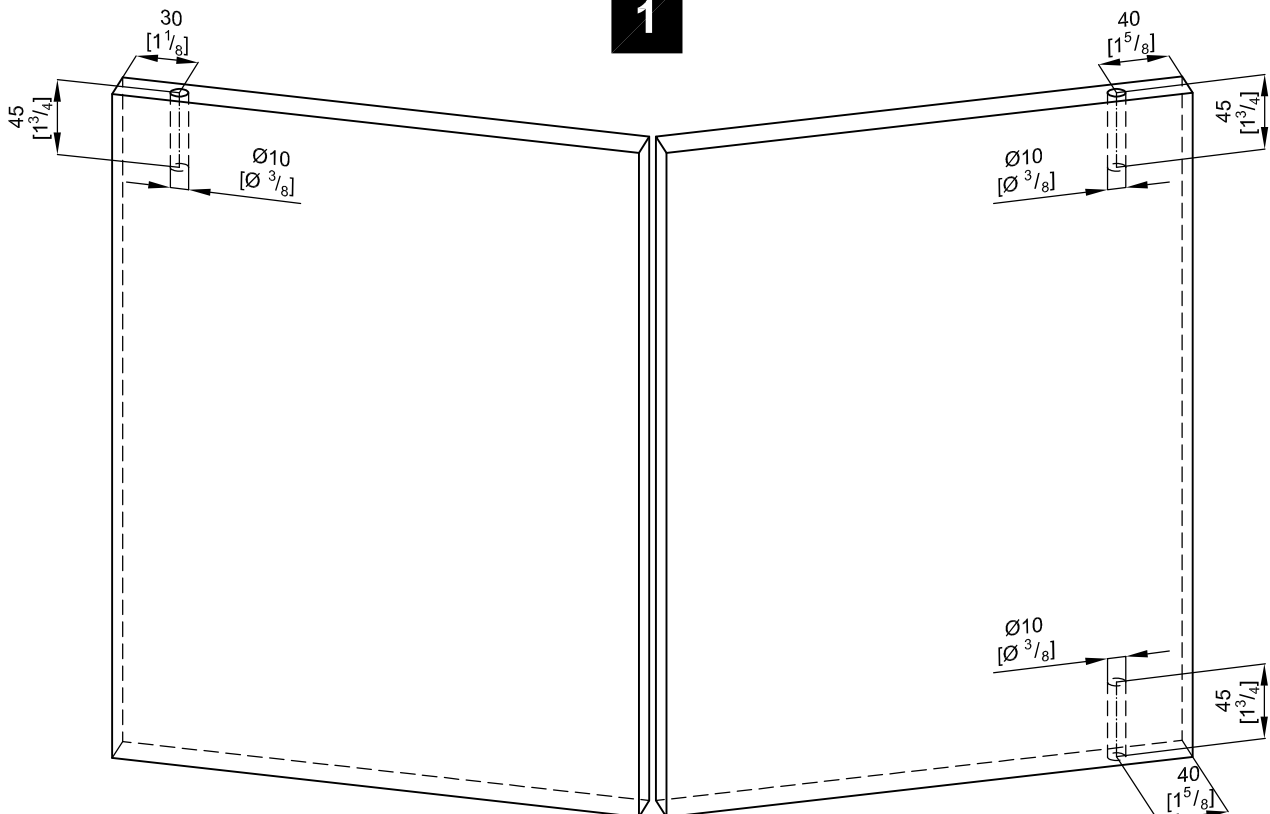

2

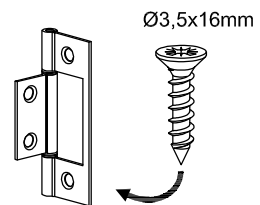
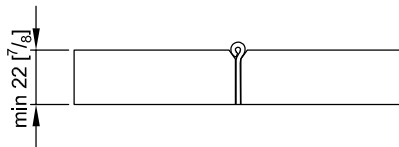
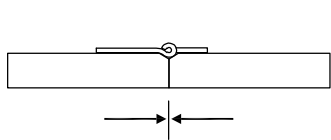

3

